

THIS DOCUMENT CONTAINS DATA PROPRIETARY TO PROJECTS UNLIMITED, INC. ANY USE OR REPRODUCTION, IN ANY FORM, WITHOUT PRIOR WRITTEN PERMISSION OF PROJECTS UNLIMITED, INC. IS PROHIBITED.
© 2003, Projects Unlimited Inc.

SPECIFICATIONS

PARAMETERS	VALUES	UNITS
RESONANT FREQUENCY	6,500±500	Hz
RESONANT IMPEDANCE (MAX)	500	Ohm
MAX INPUT VOLTAGE	30	Vp-p
CAPACITANCE @ 1KHz	14,000±30%	pF
PLATE MATERIAL	BRASS	-
OPERATING TEMPERATURE	-20 ~ +60	°C
STORAGE TEMPERATURE	-20 ~ +70	°C

REVISIONS			
LTR	DESCRIPTION	DATE	APPROVED
-	RELEASED FROM ENGINEERING	11/28/01	
A	REVISED TO NEW TEMPLATE	9/4/03	R.W.
B	REVISED SPECIFICATIONS	1/12/04	R.W.
C	REVISED DIMENSION SIZE AND STYLE	01/19/06	B.R.

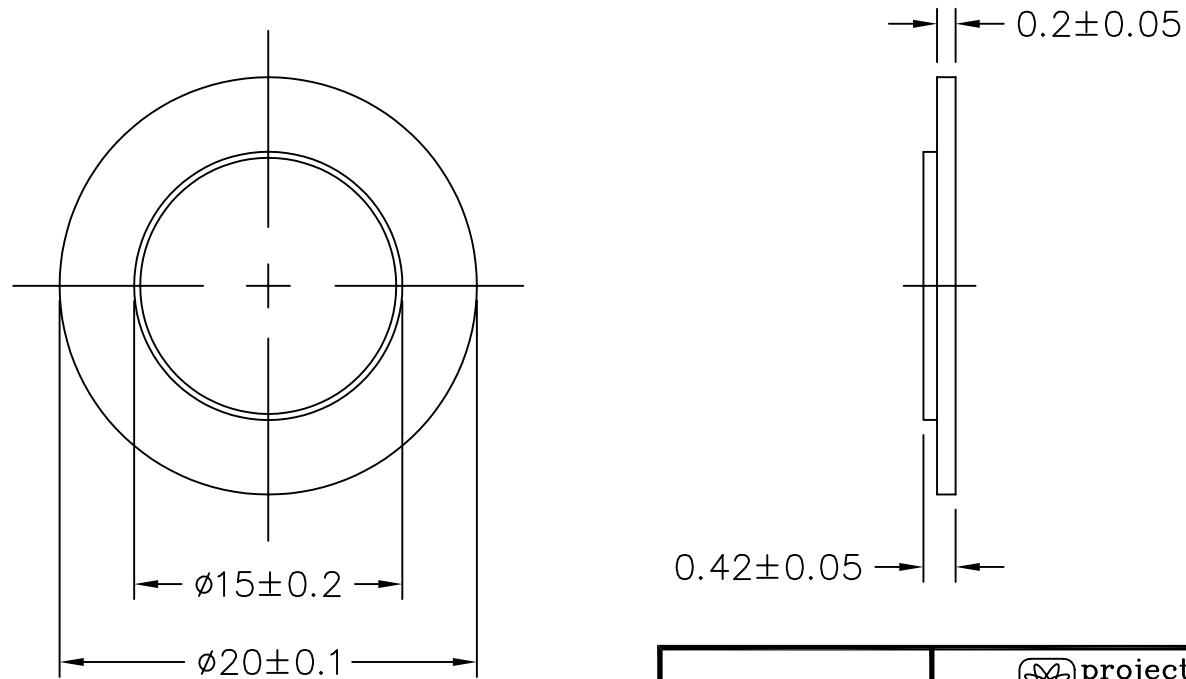

NOTES:

1. ALL DIMENSIONS ARE IN MILLIMETERS.
2. SPECIFICATION SUBJECT TO CHANGE OR WITHDRAWAL WITHOUT NOTICE.

FILE NAME
AB2065B.DWG

UNLESS OTHERWISE SPECIFIED: DIMENSIONS ARE IN MILLIMETERS; TOLERANCES ARE ±0.5 AND ANGLES ARE ±3°.		 projects® unlimited Dayton , Ohio	
APPROVALS	DATE	PIEZO CERAMIC BENDER DRAWING NO. AB2065B	
DRAWN <i>RABL</i>	11/01		
APPROVED <i>S.J.</i>	11/01		
DO NOT SCALE DRAWING		SIZE A	SHEET 1 OF 1 SCALE: N.T.S.